

## LTCAWIFI - 5.5W Smart Wi-Fi RGBW Candle Lamp

Please read these instructions and retain them for future reference.

### Important information

These products are designed for connection to a 220-240V mains supply. Always switch off mains supply before installation.

### Dimensions(mm):

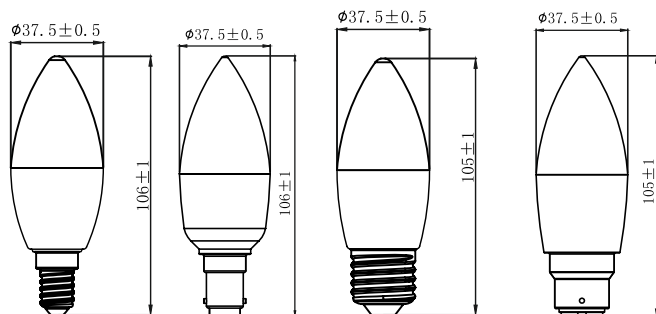

2.4Ghz  
Wi-Fi



SCAN THE QR CODE to download the APP or search "Smart Life" on your App Store or Android Market by Mobile Phone.

### Smart Life APP Instructions:

1. **Download Smart Life APP** - Scan the QR code on the right to download the Smart Life APP. You can also search "Smart Life" in either App Store or Google Play to install the APP.
2. **Register a Smart Life account and sign in to the app** - You will be prompted to enter your mobile number or email address to register. The system automatically recognises your country / area. You can also select your country code. Note: If you use a Mobile number you will be sent a text message with your confirmation code to complete your account registration.
3. **Add lamp to Smart Life APP** - Tap the icon "+" on the top corner of "My device" page and choose your device type - Smart lighting (see Fig.1 and Fig.2).

Fig.1

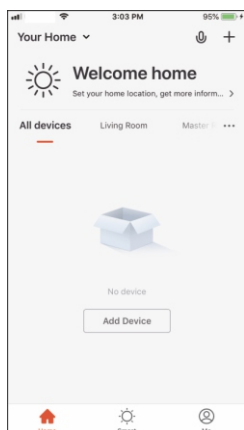

Fig.2



4. Ensure the lamp is **quick flashing** (2 times per second). If the lamp isn't flashing turn the switch OFF/ON 3 times until the LED lamp starts to flash.

5. Enable the Bluetooth on your device. Inside the APP, Bluetooth will send a notice with the devices found. Click on "Go to add" on lower right corner to add the devices discovered (Fig.3). Multiple devices can be detected at once. Select the device you want to install from the list and tap "+" to add it in the APP (Fig.4).

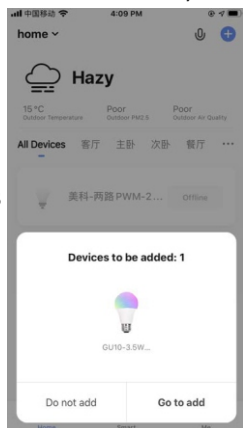

Fig.3

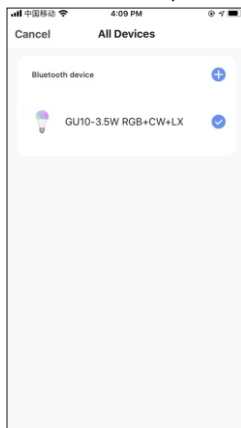

Fig.4

6. Confirm the WiFi network and password (Fig.5). Make sure your router, mobile and lamp are as close as possible.

**Note:** This item works only on a **2.4GHz WiFi network**, not on a 5GHz WiFi network. Please consult the manual of your router for settings.

7. When connecting the device, you can see the connection status as shown in Fig. 6. Once connected, enter the device name. If you want to use the device with Amazon Alexa and/or Google Assistant, the same device name will be used by these APPs to control it.

Select the location of the device in your smart home and press "Done" to access the control page of your new device (Fig.7). Your new light is ready to be controlled via the APP, even remotely (Fig.8).

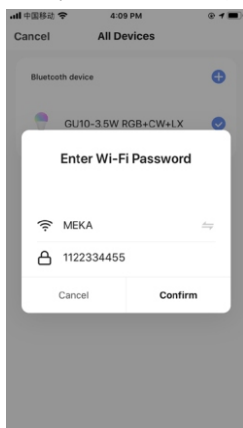

Fig.5

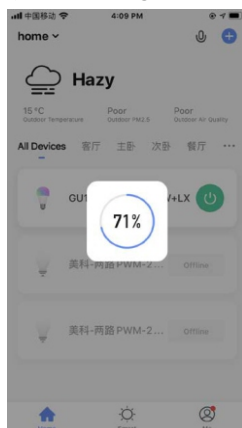

Fig.6



Fig.7

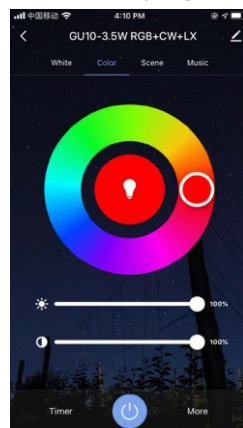

Fig.8

- Note:**
1. If the device is not connected to the Smart Life APP it will flash quickly for 3 minutes. The light will become still after 3 minutes. Turn the switch OFF/ON 3 times to re-enter pairing mode.
  2. If a connected device is reset by mistake, the device will be reconnected automatically after quickly flashing for 3 minutes or after the switch is turned OFF/ON 1 time.

For more information on pairing, grouping or other APP functions please visit [www.tlc-direct.co.uk](http://www.tlc-direct.co.uk).

Compatible with Amazon Alexa and Google Home/Assistant

