



QURW01

1A WiFi Dimming Receiving Controller



The WiFi Quinetic dimming wireless controller with a high-efficiency switching power supply has a wide voltage range with excellent stability and durability. It can be controller by a smartphone APP (iPhone and Android) and has a load capacity of 1.0A. The WiFi wireless receiving controller is equipped with an in-rush current suppression function thus creating a safe and durable product.

QURW01 - Quinetic Wireless Controller Specifications:

- Power Supply Type:** AC200V - 240V, 50/60Hz
 - Sensitivity:** 110dBm
 - Control Load:** 1.0A Fused
 - Max Load:** 100W for LED lighting
200W for other loads*
 - Weight:** 25g
 - Life Time:** 200,000 times on/off
 - Work Environment Temperature:** -20°C ~ 55°C
 - Control Distance:** 80m (outdoor) / 30m (indoor)
 - Control Method:** WiFi through Phone APP
(search " Kinetic Switch" in store)
and pairing with Quinetic Wireless Switch
 - Integrated push-in terminals for quicker installation**
- * Maximum loads may vary from manufacturer to manufacturer of the load.



QURW01



NEW
Integrated
Push-in Terminals

WiFi Receiver controls:

The Android and iOS app can be used to pair the Quinetic switches to the WiFi receiver, to turn the light ON/OFF and set the brightness of the controlled lamps. In order to add the receiver to the phone APP the phone and the receiver must use the same wireless router.

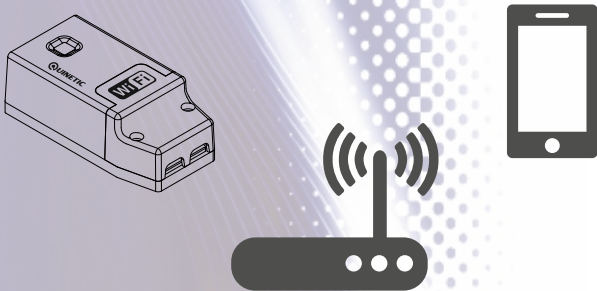

- Search **Kinetic Switch** application on your AppStore or Android Market and download and install it on your iOS device (iPhone, iPad) or on your Android device.

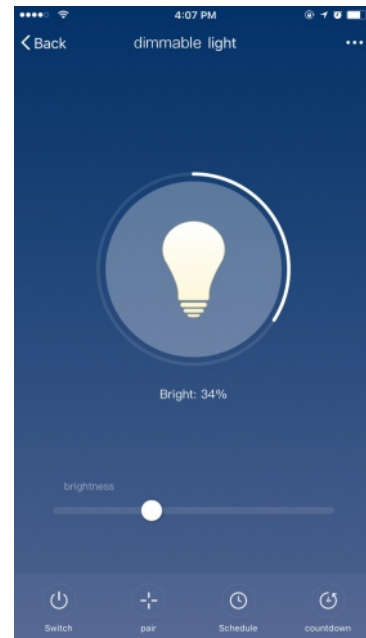
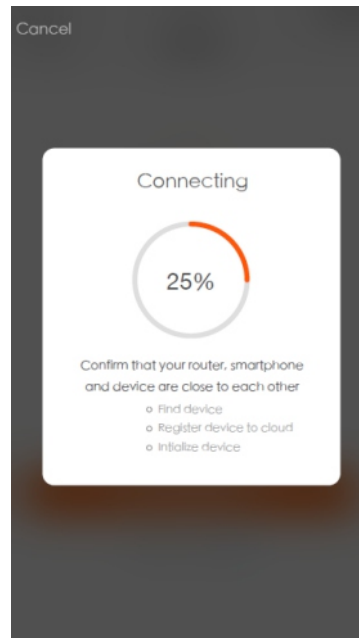

Product Dimensions

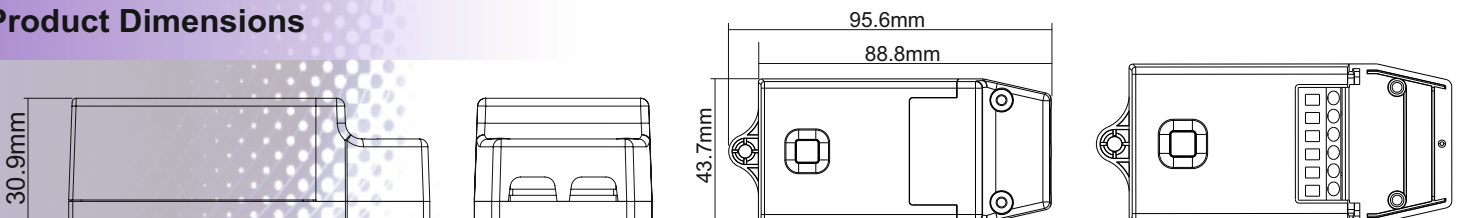



WiFi Controller features:

- Can stand 380V AC electric current for 24 hours, over voltage (<600V) will not damage it.
- Max control load - 1.0A
- Advanced RF technology, multiple algorithm ensures telecommunication stability.
- For each press and radio transmission, the channel is occupied by the wireless signal for only 1 millisecond, and each transmission is done with 3 septal frames; the control is stable and reliable.
- 32 bit device ID, 4 billion keys, chance of miss control is extremely low.

Amazon ALEXA compatible:

The WiFi Quinetic receiver can be controlled by Amazon Alexa APP - just add the skill "Smart Life" to Alexa APP and then discover the device in Alexa APP "Smart Home".



Voice control can be used in Alexa APP:
"Alexa, turn on/off bedroom light"
"Alexa, set bedroom light to 50 percent"
"Alexa, brighten/dim bedroom light"



Self Powered



No Radiation

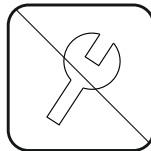

No Maintenance

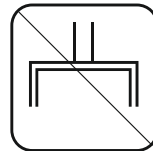

No Wiring

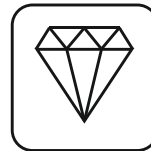

Durable



Cost Saving

Quinetic Controller Wireless Systems

The wireless Quinetic energy switch and wireless receiving controller can be paired with any combination: a controller can be controlled by a maximum of 10 separate switches, a switch can pair an unlimited number of controllers.

1-Way Wireless System

Single-Multi-Control

Quinetic Wireless Switch

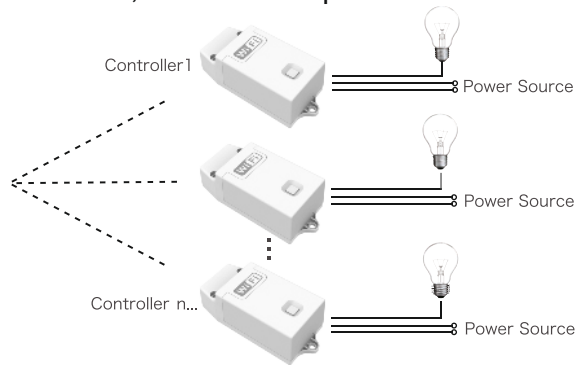

2-Way Wireless System

Dual Control

Quinetic Wireless Switch 1
Quinetic Wireless Switch 2

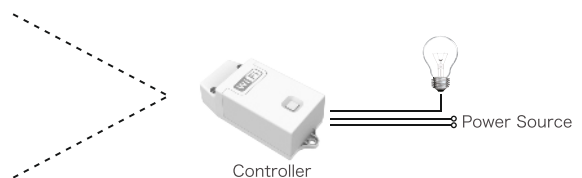

3-Way Wireless System

Multi-Single-Control

Quinetic Wireless Switch 1
Quinetic Wireless Switch 2

