





QUPEN6

Quinetic 6 Inch Smart Pendant

 <p>QUINETIC</p> <p>QUPEN6</p> <p>Quinetic 6 Inch Smart Pendant</p> <p>Installation Instructions</p>  <p>Read all instructions before installation</p>	<p>Specifications</p> <p>Product Code: QUPEN6 Voltage range: 200-240V 50/60Hz Working environment temperature: -20°C - 55°C Control distance*: 40m outdoor, 18m indoor Capacity: Up to 10 switches can be paired with one controller Control method: WiFi through Device APP (search "Kinetic Switch" in store) and pairing with Quinetic Wireless Switch (see instructions) Communication Way: WiFi IEEE 802.11 b/g/n 2.4G & RF 433MHz Lamp Holder: BC / B22 Cable Length: 6 Inch Standby Power Consumption: <1W Wiring Method: Screw Terminals Control Load: 1.0A Maximum Load: 150W LED & 200W other loads** Warranty: 3 Years</p> <p>*Distance comes from Quinetic laboratory test results. The actual distance in practical use might vary due to environmental difference.</p> <p>**Maximum load rating may vary depending on manufacturers specifications.</p>	<p>Quinetic Smart Pendant Installation:</p> <ol style="list-style-type: none"> 1. Ensure that the power is turned off before installation. 2. Pass the wires through the pendant base. 3. Use the screws provided to secure the base to the ceiling. (Fig 1) 4. Connect the Quinetic Smart Pendant using cable rating suitable for 200-240V and observing the correct polarities as per the wiring diagram (next page). 5. Rotate and tighten the top cover to the base (Fig 2)  	<p>Wiring Diagram:</p>  <p>L: Live In N: Neutral Line Lout: Live Out GND: Earth</p> <p>Kinetic Switch APP Download:</p> <p>The free Kinetic Switch App is required to operate your WiFi Smart Pendant. Ensure your iOS / Android device is connected to the internet using a Wi-Fi network.</p>  <p>Method 1:</p> <ol style="list-style-type: none"> 1. Open the App store/Google Play on your phone. 2. Search for "Kinetic Switch" in the App store or Google Play. 3. Download the Kinetic Switch App to your phone. 	<p>Method 2:</p> <p>Download the app using the QR code below:</p>  <p>Device Pairing with the APP:</p> <p>The initial setup must be performed using your 2.4Ghz Wi-Fi network (5Ghz WiFi is not supported). Both the phone and the pendant must connect to your network.</p> <ol style="list-style-type: none"> 1. After downloading the APP follow the prompts to register the account. 2. Turn on the power to the pendant and the red indicator light will flash rapidly for 10 seconds then it will stop flashing. The pendant will remain in EZ pairing mode. 3. If the light flashes differently or if you want to reset the pendant press the pairing button for 10 seconds - the light will change from slow flashing to fast flashing to still. Release the button. 4. Open the "My Home" page of the Kinetic Switch App, and click "+" on the upper right of the page. 	<ol style="list-style-type: none"> 5. Click "Light Control", select "Single Channel Controller (RF+WiFi)" and follow the instructions. 6. After successfully adding the pendant to the APP you can find the device in the "My Home" list. The smart pendant can be controlled through the App from anywhere in the world and smart scenes can be set. <p>Pairing with the APP in AP Mode</p> <p>The default configuration mode of the pendant is EZ mode (the light flashes quickly, twice per second). When pairing is not successful in EZ mode, you can pair the device to the APP using the AP mode. The steps to switch to AP mode are as follows:</p> <ol style="list-style-type: none"> 1. Press the pairing button 4 times in 1 second while in EZ mode. 2. Wait for 5 seconds and the pendant will switch to AP mode. 3. In AP mode the light will flash slowly, turning on and off once every two seconds. 4. Once the AP mode is activated on the Smart Pendant, open the "My Home" page of the Kinetic Switch App, and click "+" on the upper right of the page. Click "Light Control", select "Single Channel Controller (RF+WiFi)". 5. On the next page tap "EZ Mode" on the upper right corner and select "AP Mode" from the drop down list. Follow the APP instructions to pair and operate the receiver.
--	--	---	--	--	---

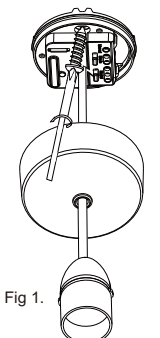
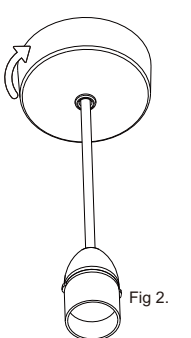
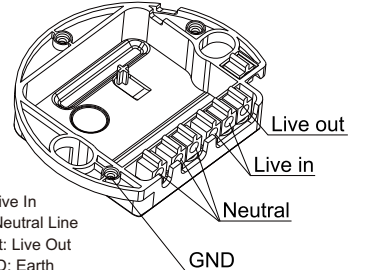
To switch from AP mode back to EZ mode, press and hold the button. The indicator light will flash quickly then stay on for a short period. Release the button and it will be in EZ mode.

Using Amazon Alexa/Google Home to control your Smart Pendant:

Note: We would recommend naming the devices in your Kinetic Switch app something that is easy for Alexa or Google Home to understand.

In order to integrate the Kinetic Switch app with Amazon Alexa/Google Home you need:

- 1) Amazon Alexa APP / Google Home APP
- 2) Amazon Alexa / Google Home account (users need to register their own account)
- 3) Echo, Echo Dot, Tap or other Amazon voice-operated devices.
- 4) Google Home, Google Home Mini or other Google voice-operated devices.

Enable Smart Life skill/action in your Alexa / Google Home APP:

Search for "Smart Life" skill and add it to the Alexa APP "Smart Home" skills. For Google Home search for "Smart Life" action and add it to Home Control. Enable the skill/action in your Alexa/Google APP and input the name and password used to register the Kinetic switch APP to link it with Alexa/Google APP.

Voice control can now be used to control the Wifi device as follows:

"Alexa/Ok Google, turn on/off [kitchen light]"
 "Alexa/Ok Google, set [bed light] to 50 percent"
 "Alexa/Ok Google, brighten/dim [bedroom light]"
 "Alexa/Ok Google, turn on [entrance light]"

Pairing with Wireless Quinetic Switches:

Quinetic WiFi Smart Pendant receiving controller and Quinetic wireless switches can be paired with any combination:

- A pendant can be operated by a maximum of 10 separate switches per channel
- A switch can pair with an unlimited number of pendants.

Bridging Mode:

The range of a switch may also be extended by using a second pendant and putting it into "**Bridging Mode**". In order to extend the distance, the second pendant or controller must be paired with the switch and located between the switch and the pendant that is out of range.

The Bridging Mode can be enabled on the second pendant/controller by following the pairing steps below (Physical Pairing Steps No.6). Once the second pendant/controller is in Bridging Mode and paired with the switch it will forward the signal from the switch to the pendant situated outside of controlling range.

App Pairing Method:

Enter the App page of the Smart Pendant and click "Pairing" -> "Start Pairing". After the App page displays "Waiting for pairing", press any button of the wireless Quinetic switch that needs to be paired. This will complete the pairing. The App will prompt "Pairing succeeded" after the pairing is completed.

Physical Quinetic Wireless Switch Method:

1. Press the pairing button for 3 seconds and the indicator light will flash slowly. Release the button to enter pairing mode.
2. Press any gang of the wireless kinetic energy switch and the indicator light of the controller will go out, confirming that the pairing is successful.
3. Pressing the switch quickly will turn the light ON/OFF. Keep the switch pressed to dim the light to the desired level. While the switch is pressed the lights will go down from 100%-0% and then will go up 0-100%. Please note that the dimming range of the pendant is slightly shorter when manually operated by the switch compared to the APP dimming range. The dimming range varies for LED lamps as there are different LED dimmable driver solutions.

4. If you need to add more switches to the same pendant please repeat the above process; each pendant can store up to 10 switches.
5. Single, double and triple switches follow the same pairing method.
6. In order to extend the range of a switch using the "**Bridging Mode**" on the pendant, press the function button for 7 seconds until the red LED light changes from slow to fast flashing and release the button. The red LED will start flashing once every 2 seconds to indicate the successful bridging.
7. To disable the bridge mode, repeat the above steps.
8. If the pendant indicator light continues to pulse the controller will still function normally even if used with a Quinetic switch.
9. To clear the pendant stored pairing information press function button for 15 seconds until the indicator light goes out - the pairing information will be deleted.

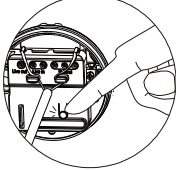

Press for 3 seconds to enter pairing mode

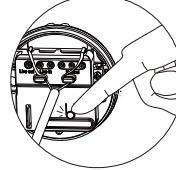

Press for 15 seconds to clear memory

Wifi Pairing Reset Procedure:

To reset the pendant's WiFi pairing with the APP press function button for 10 seconds until the indicator light changes from flashing to still and release the button. The indicator light will enter fast flashing mode and the device will be removed from the APP and reset.

Precautions:

1. The wiring must be done in accordance with the method of installation illustrated.
2. Please note the maximum load of an individual pendant. Exceeding this maximum will result in damaging the pendant.
3. The pendant has a non-replaceable internal fuse.
4. Do not short-circuit, it may cause permanent damage to the pendant.
5. The pendant will remain "OFF" after a power cut until reactivated by a switch, saving energy, reducing fire risk and protecting your appliances.
6. Damage caused by incorrect installation and operation are not covered under warranty.

Troubleshooting:

1. If pairing does not work, first check if the indicator is lit. Re-pair in case the pairing is lost after power failure.
2. If the pendant does not respond check the LED indicator. If it does not light check the power supply.
2. WiFi internet pairing fails: confirm the light is flashing quickly (twice per second). If not, please set the light to flash quickly according to connect WiFi method.

The router, pendant and phone should be as close as possible (within 5 metres).

3. The pendant is offline in APP: Router connections might reach the upper limit. Some routers allow a maximum of 15 devices. In this case please upgrade the router and/or close any devices which are not needed.

Dimensions:

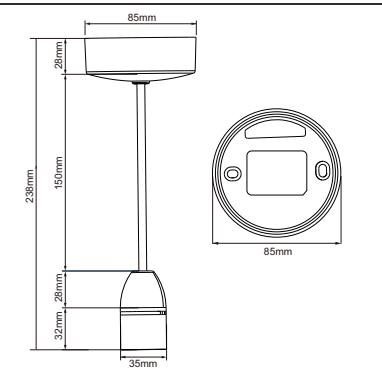

*For more information about phone APP pairing, instructions and troubleshoot please visit www.tlc-direct.co.uk website.