

TIMEGUARD®

10W LED Slimline PIR Floodlight – Single Flood

Model: LED100PIRBE – Black
Model: LED100PIRWHE – White



Installation & Operating Instructions

1. General Information

These instructions should be read carefully and retained for further reference and maintenance.

2. Safety

- Before installation or maintenance, ensure the mains supply to the luminaire is switched off and the circuit supply fuses are removed or the circuit breaker turned off.
- It is recommended that a qualified electrician is consulted or used for the installation of this luminaire and install in accordance with the current IEE wiring and Building Regulations.
- Check that the total load on the circuit including when this luminaire is fitted does not exceed the rating of the circuit cable, fuse or circuit breaker.

3. Technical Specifications

- 230V AC 50Hz
- This luminaire is of class I construction and must be earthed
- 10W LED Non replaceable lamp
- Energy Usage: 10Kwh/1000H
- Lumen Output: 840lm
- Motion Detection Range: Up to 10m at 2.5m mounting height
- Detection Angle: 180°
- Lamp Adjustment Pan and Tilt: **Wall Mount** – Left and Right 40° (limited by wall), Downward 70°
Wall Mount with Spacer (sold separately) – Left 210°, Right 45°, Downward 70°
Inner Corner Bracket (sold separately) – Left 210°, Right 45°, Downward 70°
Outer Corner Bracket (sold separately) – Left 90° (limited by corner), Right 45°, Downward 70°
- Time ON Adjustment: 2 seconds to 30 minutes (2s, 20s, 2m, 5m, 10m, 15m, 30m)

- Lux Adjustment: 2 to 200 lux
- Stand-by Power Consumption: 0.4W
- Warm-up Duration: 30 seconds
- Colour Temperature: 4000K
- Operating Temperature: -20°C to +45°C
- Manual Pulse Override: Double flip within 2 seconds to enter 6 hours ON time
- Back Box Mounting Centres: 60mm
- IP55 Rated suitable for restricted external applications
- CE Compliant
- Dimensions: H= 160mm, W= 80mm, D= 50mm

Other Loads – External (Slave)

- LED Lamp: Max 100W
- Halogen Lamp: Max 300W
- Fluorescent Lamp: Max 200W

Parallel Switching

- A maximum of 4 LED100PIR single floodlights can be wired in parallel to enable any detector to turn ON all the lights connected.

Note: if you have the PIR floodlights set for different time durations, and you trigger more than one PIR sensor, the light will stay ON for duration of the highest set time.

4. Selecting a Location

- The PIR sensor has number of detection zones, at various vertical and horizontal angles as shown. See image A.

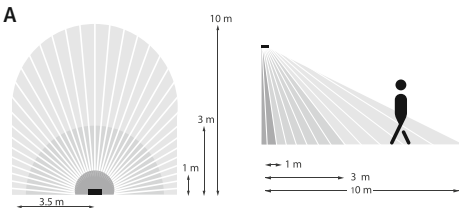

- A moving human body needs to cross/enter one of these zones to activate the PIR sensor. The best all-round coverage is achieved with the floodlight mounted at the optimum height of 2.5 metres. See image B.

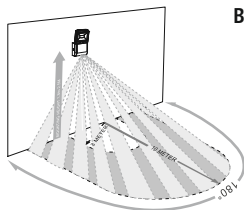

- Careful positioning of the PIR sensor will be required to ensure optimum performance.
- The PIR sensor is more sensitive to movement ACROSS its field of vision than to movement directly TOWARDS (See image C). Therefore position the floodlight so that its PIR sensor looks ACROSS the likely approach path.
- Avoid positioning the floodlight where there are any sources of heat in the detection area of its PIR sensor (extractor fans, tumble dryer exhausts etc.) including opposite any other light sources such as other security floodlights.

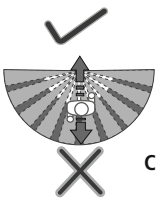
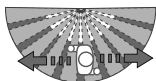

- Reflective surfaces (i.e. pools of water or white painted walls) and overhanging branches may cause false activation under extreme conditions.
- During extreme weather conditions the PIR sensor may exhibit unusual behaviour. This does not indicate a fault with the product. Once normal weather conditions return, the PIR sensor will resume normal operation.

3

5. Installation

- 5.1 Ensure the mains supply is switched off and the circuit supply fuses are removed or the circuit breaker turned OFF (See image 1).

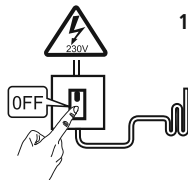

B

C

1

- 5.2 An isolating switch should be installed to enable the power to be switched ON and OFF for maintenance purposes and to activate the manual/auto override function.
- 5.3 Disconnect the back box from the luminaire by releasing the lugs (left or right side). See Image 2.
- 5.4 Firmly grip the back box with your hand, from top and bottom and carefully pull away from the luminaire. See Image 3.
- 5.5 Mark the position of the mounting holes on the wall using the back box as a template (See image 4). Drill the holes ensuring not to infringe with any gas/water pipes or electrical cables that may be hidden below the surface. Insert the rawl plugs into the holes. Pass the 230V 50Hz supply and load cables through the cable entry points on the back box, ensuring the grommets are used to maintain the IP rating of the luminaire.

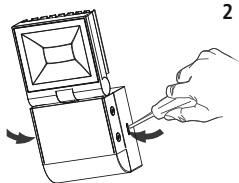

2

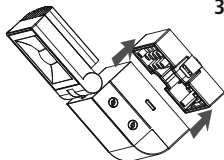

3

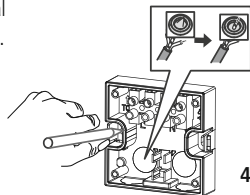

4

- 5.6 Fix the back box to the wall using the 2 mounting screws, making sure it is the correct way up. Take care not to over-tighten the screws to prevent damage to the back box. If using a power screwdriver, use the lowest torque setting. See image 5.

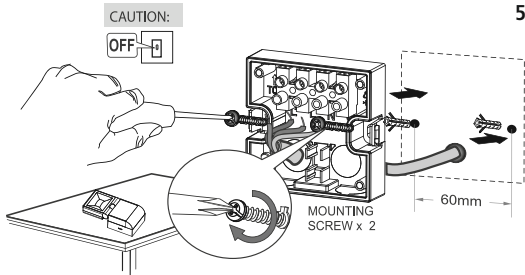

5

- 5.7 Terminate the 230V 50Hz mains supply cable into the terminal block (See image 6) ensuring correct polarity is observed and that all bare conductors are sleeved (See section 6. Connection Diagram – for wiring details).

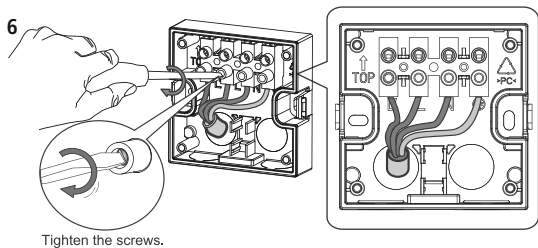

- 5.8 Re-connect the luminaire to the back box ensuring the 2 lugs firmly latch on the left and right hand side, indicated by a 'click'. See image 7.

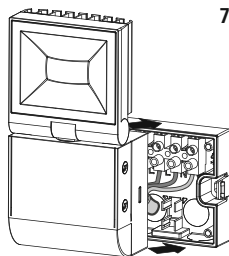

6. Connection Diagram

230V AC 50Hz MAINS SUPPLY

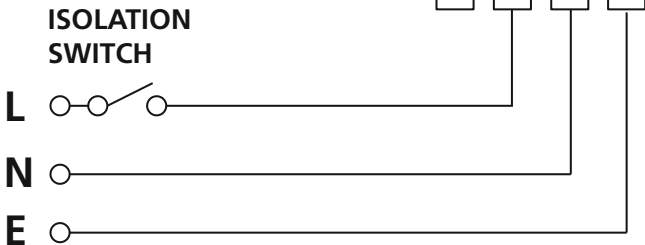

6

Connect the 3 core mains supply cable top the terminal block on the back box as follows:

Live Supply (Brown or Red) to	L
Neutral Supply (Blue or Black) to	N
Earth (Green/Yellow) to	

For additional external (slave) lighting, connect the external load to the terminal block on the back box as follows:

Live Supply (Brown or Red) to	L ¹
Neutral Supply (Blue or Black) to	N
Earth (Green/Yellow) to	

Parallel Switching

- A maximum of 4x LED100PIR single floodlights can be wired in parallel to enable any detector to turn ON all the lights connected.
- Please refer to the following diagram which shows an example of 2x LED100PIR single floodlights connected in parallel, with 2 slave floodlights at the same time:

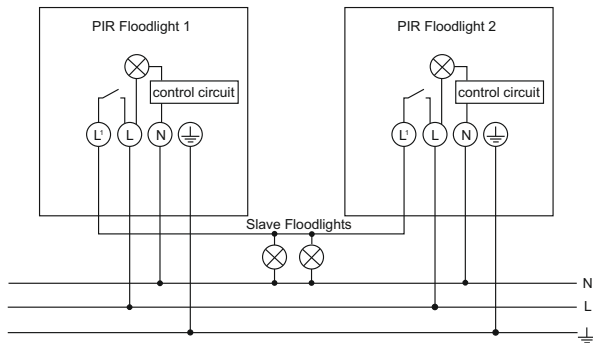

7. Setting Up

Walk Test Procedure (Test Mode)

- Make sure the PIR sensor is set to Test Mode i.e. the TIME ON Adjustment to the minimum (fully anti-clockwise), and the Lux Level set the Sun symbol (fully clockwise). We recommend using the knob adjuster included in the accessory pack to adjust the Time and Lux settings, however a thin flat head screwdriver or a 2.5mm Allen key could also be used.
- Turn the power to the unit ON.
See image 8. The lamp will immediately illuminate as the unit goes through its "warm-up" period. After approximately 30 seconds the lamp will extinguish. This indicates the unit is wired correctly and the unit is in Test Mode.
- Try to remain outside the detection area during the warm-up period.

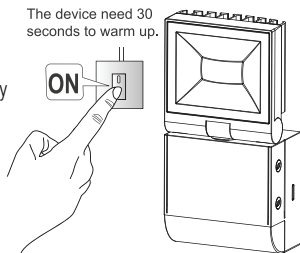

- The unit will now operate during daytime as well as at night, illuminating the lamp for approx. 2 seconds each time. This allows testing to be carried out to establish whether the sensor is covering the required area.
- Walk across the location the sensor is fitted, to establish the detection zone.
- The sensor will detect you approximately up to 10 meters forward at mounting height of 2.5m.
- As you cross the detection “zone” the lamp will illuminate. Now stand still until the lamp extinguishes (this should take approx. 2 seconds).
- Start moving again after 5 seconds. Each time you cross the detection “zone” the lamp will illuminate.
- Repeat the above, walking at various distances and angles to the unit. This will help you to confirm the detection pattern.

Setting Up for Automatic Operation (Auto Mode)

- When walk tests are complete, the unit can be adjusted for automatic operation.
- The TIME ON adjustment controls how long the unit remains illuminated following activation and after all motion ceases.
- Use a thin flat blade screwdriver to make adjustments. We recommend using the knob adjuster included in the accessory pack to adjust the Time and Lux settings, however a thin flat head screwdriver or a 2.5mm Allen key could also be used.
- This can be set between 2 seconds to a maximum of 30 minutes.
- Set the control to the desired setting between these limits.
- The LUX Level adjustment determines the level of darkness required for the unit to start operating. The setting is best achieved by the procedure below;
 1. Set the LUX Level adjustment knob fully clockwise (Sun symbol).
 2. When the ambient light level reaches the level of darkness at which you wish the lamp to become operative (i.e. at dusk) SLOWLY rotate the control in an anti-clockwise direction until a point is reached where the lamp illuminates.
 3. Leave the control set at this point.
- At this position the unit should become operative at approximately the same level of darkness each evening.
- Observe the operation of the unit. If the unit is starting to operate too early (i.e. when it is quite light) adjust the control slightly anti-clockwise.

If the unit starts to operate too late (i.e. when it is very dark).
Adjust the control slightly clockwise.

- Continue to adjust until the unit operates as desired.

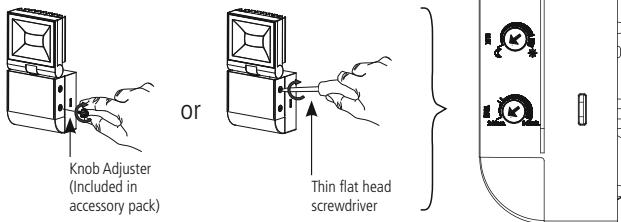

8. Lamp Adjustment

- Pan/Tilt adjustment including details when using the optional spacer and corner brackets (sold separately).

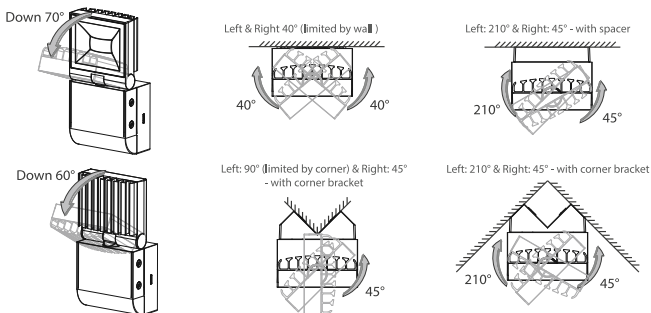

9. Manual Override

- The light can be switched ON for longer time periods by use of the Manual Override Mode. This can be activated at night time (only) by using the internal wall switch or circuit breaker.
- Switch the internal wall switch twice (OFF/ON, OFF/ON) within 2 seconds. The floodlight will now illuminate continuously for 6 hours, or until it is switched back into Auto Mode.

- You are able to add an additional 6 hours ON time, by switching the internal wall switch again, twice (OFF/ON, OFF/ON) within 2 seconds.
- To return to Auto Mode, switch the internal wall switch once (OFF/ON) within 2 seconds.
- The floodlight will return to Auto Mode, and will operate normally as set up.

10. Lens Mask Sticker

- There is 1x lens mask sticker included in the accessory pack.
- The purpose of the lens mask sticker is to mask out areas not desired for detection. You can restrict left or right detection, or reduce detection zone to cover a smaller area.

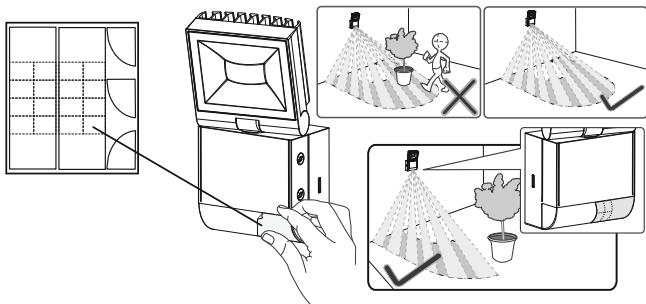

10

3 Year Guarantee

In the unlikely event of this product becoming faulty due to defective material or manufacture within 3 years of the date of purchase, please return it to your supplier in the first year with proof of purchase and it will be replaced free of charge.

For years 2 and 3 or any difficulty in the first year, telephone the helpline on 020 8450 0515.

Note: A proof of purchase is required in all cases. For all eligible replacements (where agreed by Timeguard) the customer is responsible for all shipping/postage charges outside of the UK. All shipping costs are to be paid in advance before a replacement is sent.

If you experience problems, do not immediately return the unit to the store. Telephone the Timeguard Customer Helpline;

HELPLINE

020 8450 0515

or email helpline@timeguard.com

Qualified Customer Support Co-ordinators will be on-line to assist in resolving your query.



A **theben** Group Company

For a product brochure please contact:

Timeguard Limited.

Victory Park, 400 Edgware Road,

London NW2 6ND

Sales Office: 020 8452 1112

or email csc@timeguard.com

www.timeguard.com